

1"

133 l/min

**PRO  
Series**







## 1" metallic diaphragm pump

Pompe métallique à membranes 1"

Bomba metálica de membrana, 1"

Pompa metallica a membrana da 1"

### Specifications – Especificaciones – Caratteristiche

 ?:1	1:1
 1 min.	133 l/min
 Cycle	0.60 litre
 Max. bar	8.3 bar (120 psi)
 Max.	3.2 mm
 Max.	6.10 m
	666100... <b>8.60 kg</b> (aluminium) 666101... <b>16.3 kg</b> (stainless steel inox) 666102... <b>14.1 kg</b> (cast iron · fonte hierro fundido ghisa)



666100-3EB-C

### Ordering menu • Codification • Codificación • Informazioni per l'ordinazione

Center section Partie moteur Sección central Sezione centrale	Fluid Caps / manifold material Matériau partie mouillée / raccordement Material de las tapas de fluido / conexión Materiale tappi fluido / collettore	Seat material Matière siège Material asiento Materiale sede	Ball material Matière bille Material bola Materiale sfera	Diaphragm Membrane Membrana Membrana	
 <b>ATEX certified</b> <b>0</b> Aluminium, NPTF <b>1</b> Cast iron, NPTF Fonte, NPTF Hierro fundido, NPTF Chisa, NPTF <b>2</b> Aluminium, BSP <b>3</b> Cast iron, BSP Fonte, BSP Hierro fundido, BSP Chisa, BSP	<b>0</b> Aluminium / Steel hardware Aluminium / Visserie acier Aluminium / Tornillería de acero Alluminio / Bulloneria in acciaio <b>1</b> Stainless steel / Steel hardware Inox / Visserie acier Acero inox. / Tornillería de acero Acciaio inox / Bulloneria in acciaio <b>2</b> Cast iron / Steel hardware Fonte / Visserie acier Hierro fundido / Tornillería de acero Ghisa / Bulloneria in acciaio <b>9</b> Stainless steel / Dual outlet / Steel hardware Inox / Sortie double / Visserie acier Acero inox. / Salida doble / Tornillería de acero Acciaio inox / Uscita doppia / Bulloneria in acciaio <b>A</b> Aluminium / Stainless steel hardware Aluminium / Visserie inox Aluminium / Tornillería de acero inox. Alluminio / Bulloneria in acciaio inox <b>B</b> Stainless steel / Stainless steel hardware Inox / Visserie inox Acero inox. / Tornillería de acero inox. Acciaio inox / Bulloneria in acciaio inox <b>C</b> Cast iron / Stainless steel hardware Fonte / Visserie inox Hierro fundido / Tornillería de acero inox. Ghisa / Bulloneria in acciaio inox <b>D</b> Stainless steel / Dual outlet / Stainless steel hardware Inox / Sortie double / Visserie inox Acero inox. / Salida doble / Tornillería de acero inox. Acciaio inox / Uscita doppia / Bulloneria in acciaio inox	<b>1</b> Aluminium <b>2</b> 316 Stainless steel Inox 316 Acero inox. 316 Acciaio inox 316 <b>3</b> Polypropylene <b>4</b> PVDF <b>5</b> Carbon steel Acier carbone Acero al carbono Acciaio al carbonio <b>8</b> 400 stainless steel Acier inox 400 traité dur 400 Acero Inox. (duro) 400 Acciaio inox (duro)	<b>1</b> Neoprene <b>2</b> Nitrile® <b>3</b> Viton® <b>4</b> PTFE <b>5</b> EPR <b>6</b> Acetal <b>8</b> Polyuretane <b>A</b> 316 Stainless steel Inox 316 Acero inox. 316 Acciaio inox 316 <b>C</b> Hytrel® <b>E</b> Santoprene®	<b>1</b> Neoprene <b>2</b> Nitrile® <b>3</b> Viton® <b>4</b> PTFE / Santoprene® <b>5</b> EPR <b>6</b> PTFE 1 piece diaphragm Membrane monobloc PTFE Membrana de una pieza en PTFE Membrana PTFE in un unico pezzo <b>9</b> Hytrel® <b>B</b> Santoprene®	<b>C</b> Revision 3 Révision 3 Revisión 3 Revisione 3

Total discharge head • hauteur totale de charge au refoulement  
Altura de descarga total • altezza di mandata totale

Air consumption in liters/sec • Consommation d'air en litres/seconde  
Consumo de aire en litros/segundo • Consumo d'aria in litri/sec

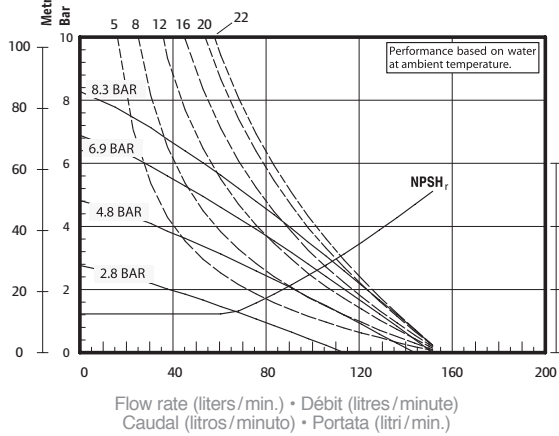

NPSH required in meters • NPSH requis en mètres  
NPSH necessario in metros • PSH richiesta in metri

### Dimensions Dimensiones Dimensioni

A (mm)	203
B	318
C	159
D	186
E	218
F	294
G	165
H	32
J	102
K	11

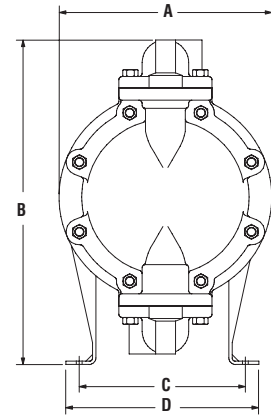

1 - 1 1/2" NPTF, Models 66610... 66611...  
Rp 1 (1-11 BSP), Models 66612... 66613...

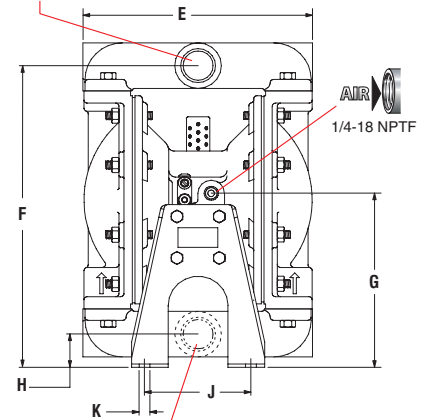

1 - 1 1/2" NPTF, Models 66610... 66611...  
Rp 1 (1-11 BSP), Models 66612... 66613...



P39224-614



48495964

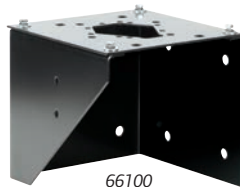

66100

### Pump accessories • Accessoires pour la pompe • Accesorios para bomba • Accessori per pompe

<b>P39224-610</b>	Filter / Regulator Piggyback – 1/4" NPT – 0 to 10 bar – filter element 5µ – metallic bowl with sight glass – gauge – manual drain Filtre / régulateur – 1/4" NPT – 0 à 10 bar – élément filtrant 5µ – bol métallique avec regard – manomètre – purge manuelle Filtro / regulador – 1/4" NPT – 0 a 10 bar – elemento filtrante 5 µ – vaso de metal con mirilla – manómetro – drenaje manual Filtro / regolatore – 1/4" NPT – 0 a 10 bar – elemento filtro 5 µ – coppa metallica con spia – manometro – drenaggio manuale
<b>P39224-614</b>	Filter / Regulator Piggyback – 1/4" NPT – 0 to 10 bar – filter element 5µ – metallic bowl with sight glass – gauge – automatic drain Filtre / régulateur – 1/4" NPT – 0 à 10 bar – élément filtrant 5µ – bol métallique avec regard – manomètre – purge automatique Filtro / regulador – 1/4" NPT – 0 a 10 bar – elemento filtrante 5 µ – vaso de metal con mirilla – manómetro – drenaje automático Filtro / regolatore – 1/4" NPT – 0 a 10 bar – elemento filtro 5 µ – coppa metallica con spia – manometro – drenaggio automatico
<b>66100</b>	Wall mount bracket Kit de montage mural Kit de montaje en pared Montaggio a parete
<b>66975</b>	Pneumatic cycle counter kit (see details page 77) Compteur de cycles pneumatique (voir description page 77) Contador de ciclos neumático (presentado en página 77) Contatore di cicli pneumatico (vedere pagina 77).
<b>48495964</b>	One piece diaphragm kit including composite PTFE diaphragms (PTFE-PA FABRIC-EPDM), connecting rod, end plate, o-ring, shim pack and grease package Kit membranes monobloc: mono membranes en PTFE composite (PTFE-PA FABRIC-EPDM), tige de connexion, plaque d'extrémité, joint torique, jeu de cales et graisse Juego de membranas de una pieza incluye diafragmas compuestos de PTFE (PTFE-PA FABRIC-EPDM), barra de conexión, plato, junta tórica, arandelas de ajuste y grasa Kit membrana in un pezzo – include: membrana in PTFE (PTFE-PA-EPDM), connessione asta, piattello, o-ring, spessori e grasso
<b>637118-C</b>	Service repair kit for air section Kits de réparation, section pneumatique Kit de reparación, sección de aire Kit di riparazione, sezione pneumatica
<b>637119-XX-C</b>	Service repair kit for fluid section Kits de réparation, section fluide Kit de reparación, sección de fluido Kit di riparazione, sezione fluidi